

Article number: 20126398RT

Description: E+G Ball knob DIN 319-KU-16-M4-C-RT

Measures

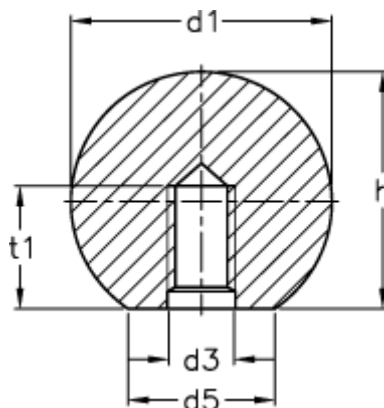

d1	= 16
d3	= M4
d5	= 8
h	= 15.0
t1 min.	= 7.0